

Quick Start Guide

1 Cold Water Connect

- Find the cold water supply under sink
- Turn the **main valve (angle stop)** off
- Remove the cold water line from the **main valve** by using a wrench

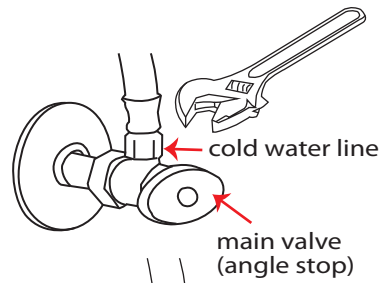

- Totally disconnect the **cold water line**

- Add Teflon tape to the male threads on both the **cold water connect** and **main valve**
- Connect the **cold water connect** to the **main valve**
- Then connect the cold water line to the **cold water connect**
- Tighten both with a wrench

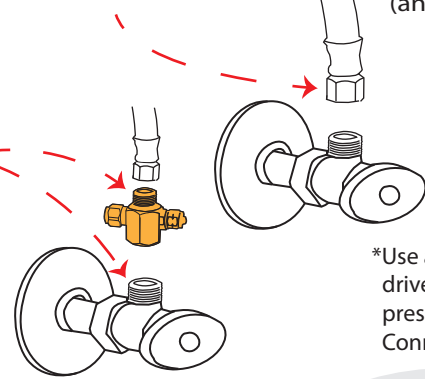

- Remove the small nut from the **cold water connect**
- Slide the tubing through it
- Connect the 1/4" tubing on to the barb fitting on the **cold water connect**
- Tighten the nut back on with a wrench

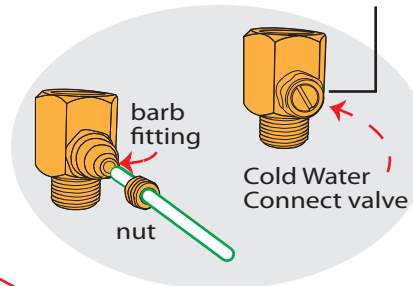

2

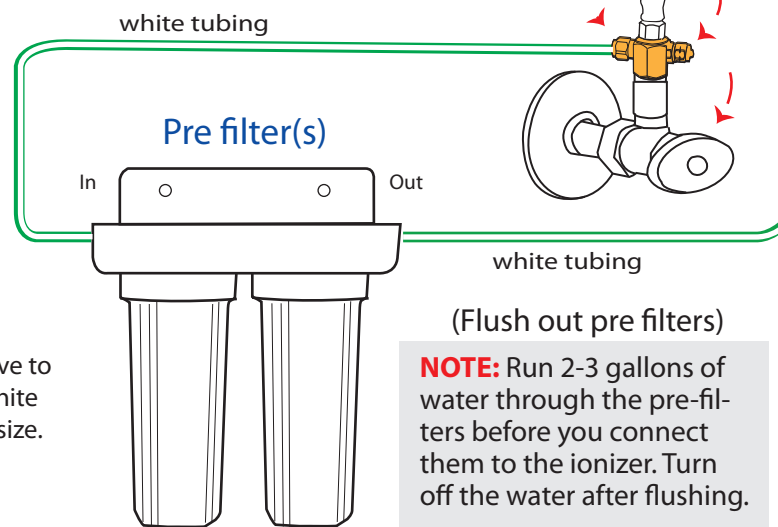

You will have to cut the white tubing to size.

(Flush out pre filters)
NOTE: Run 2-3 gallons of water through the pre-filters before you connect them to the ionizer. Turn off the water after flushing.

- Run the tubing from the **cold water connect valve** to the "IN" side of the **filter housing**
- Attach by pushing in the tubing until it clicks in place.
- Try pulling it out to make sure it is in there tight.
- Attach another piece of tubing on the other side marked "OUT" which will then lead to the sink or large container to flush Pre filters.
- Turn on the water to flush filters.

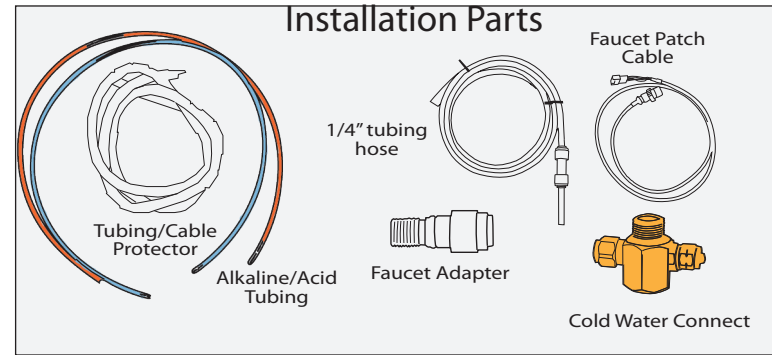

3

- Remove plugs from the **INLET/OUTLET** elbows (See page 18 in the manual for Quick Connect Fitting instructions).
- After removing the plugs from the inlet and outlet elbows, connect the tubing coming from the Pre Filter(s) "OUT" to the source water "inlet."
- Connect the orange tube to the **OUTLET** elbow
- Plug the power cord into the bottom of the ionizer.

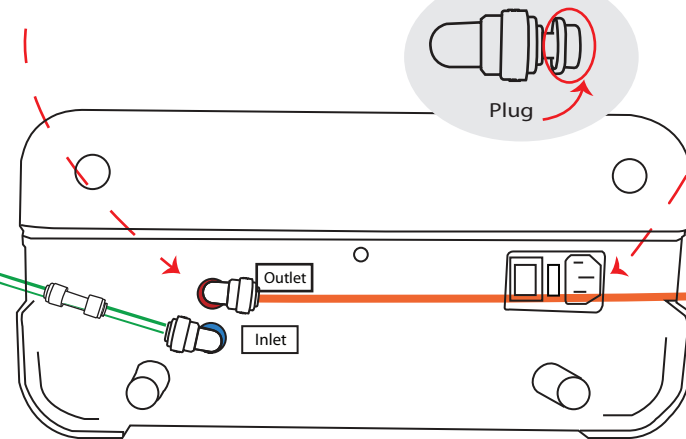

5

- Connect the **faucet adapter** to the turret until they butt up flush. This should only be hand tightened.*
- Then connect the **blue alkaline tubing** from the **faucet** to the **faucet adapter****

* No Teflon or tools are needed
** Some trimming may be needed on the tubing

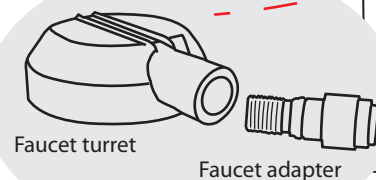

InfluenceWater.com

4

- Make sure the counter hole for the faucet is 1 3/16"
- Install the **faucet** with the black rubber gasket under the faucet base
- Tighten fixing nut from under the sink
- Connect the orange tube coming from the **OUTLET** elbow on the bottom of the ionizer, to the red tube coming from faucet at the Quick Connect Union
- Connect the blue tube coming from the **faucet adapter** on top of the ionizer, to the blue tube coming from the faucet at the Quick Connect Union
- Connect the **faucet patch cable** to the **faucet**

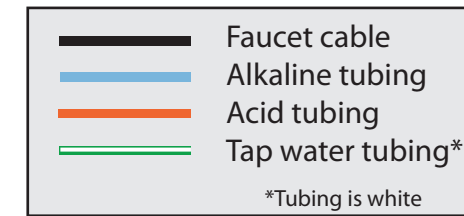

6

- Connect the **faucet patch cable** from the **faucet** to the back of the ionizer by lining up the pins on the 6 pin **plug connector**
- Push in and screw the cap down until snug
- Plug power cord into outlet

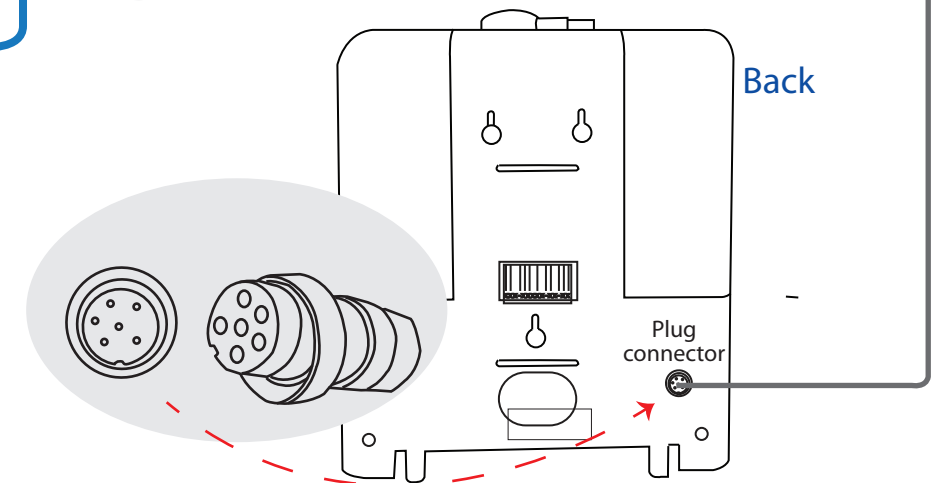

Last Step: Turn on the **main valve (angle stop)** and check for leaks.

